

nds04-05:module08:steel:a02

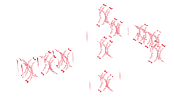

assignment

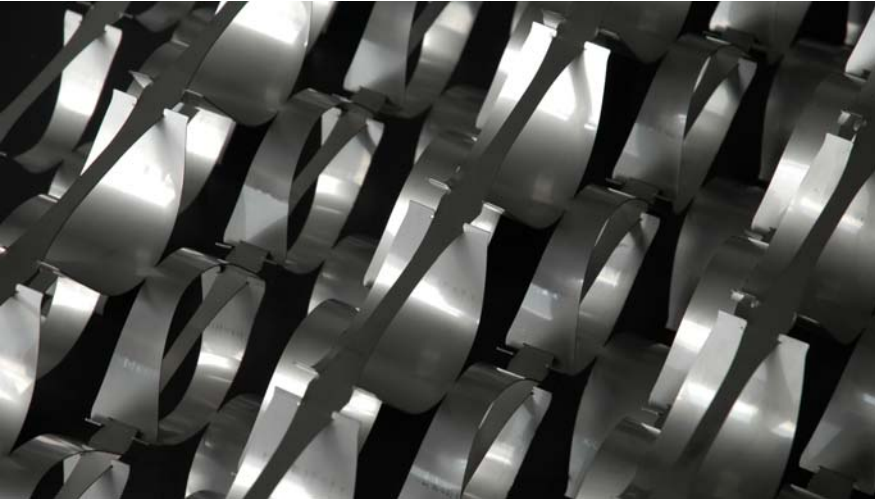

the objective is to create a paravent structure
using a maximum of 2 different elements

nds04-05:module08:steel:a02

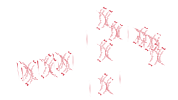

inspiration

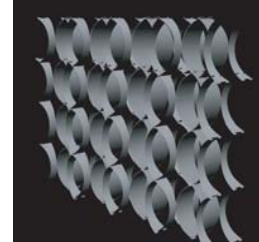
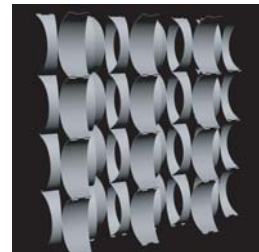
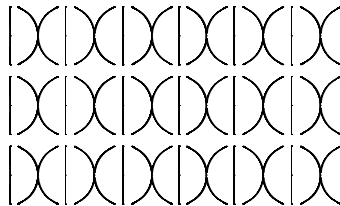

nds04-05:module08:steel:a02

elements

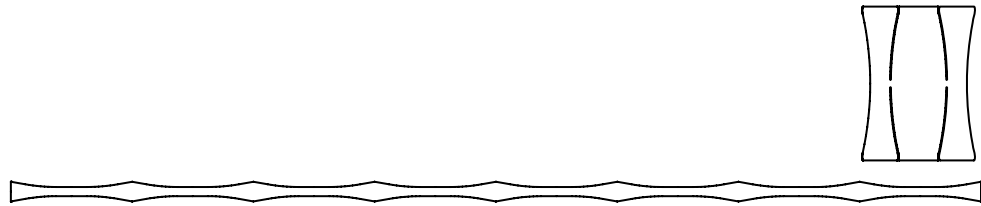
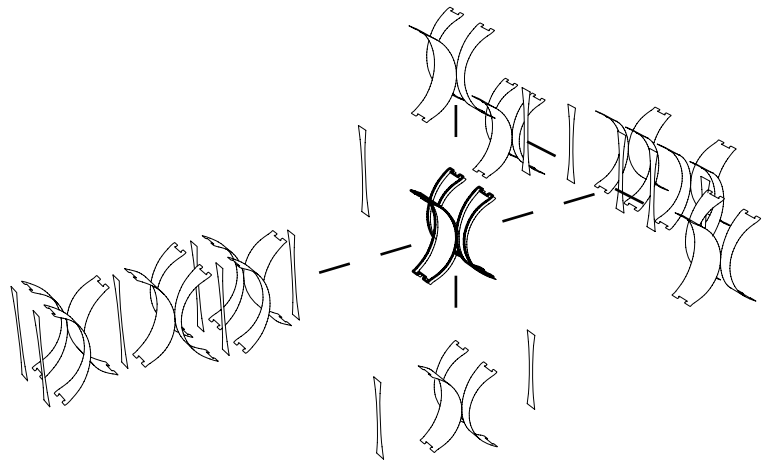

nds04-05:module08:steel:a02

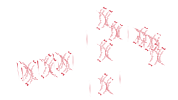

production

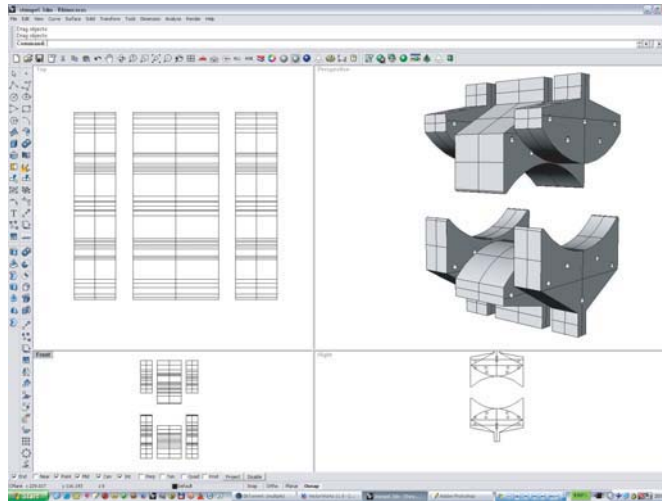
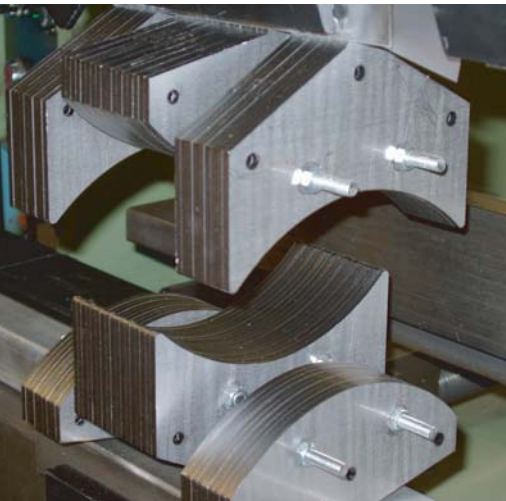

nds04-05:module08:steel:a02

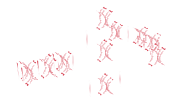

production

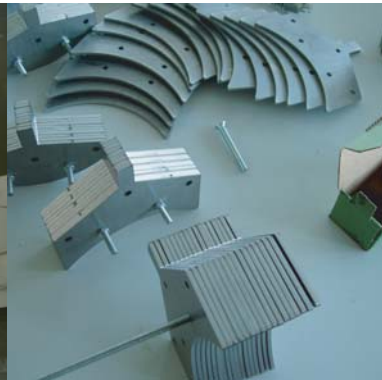

nds04-05:module08:steel:a02

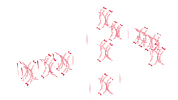

production

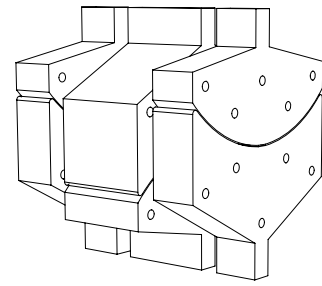
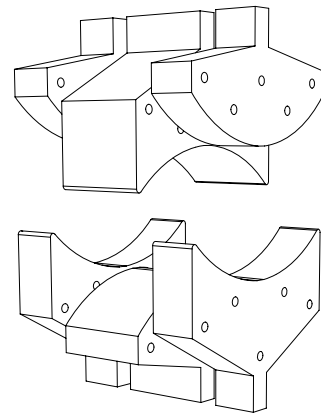
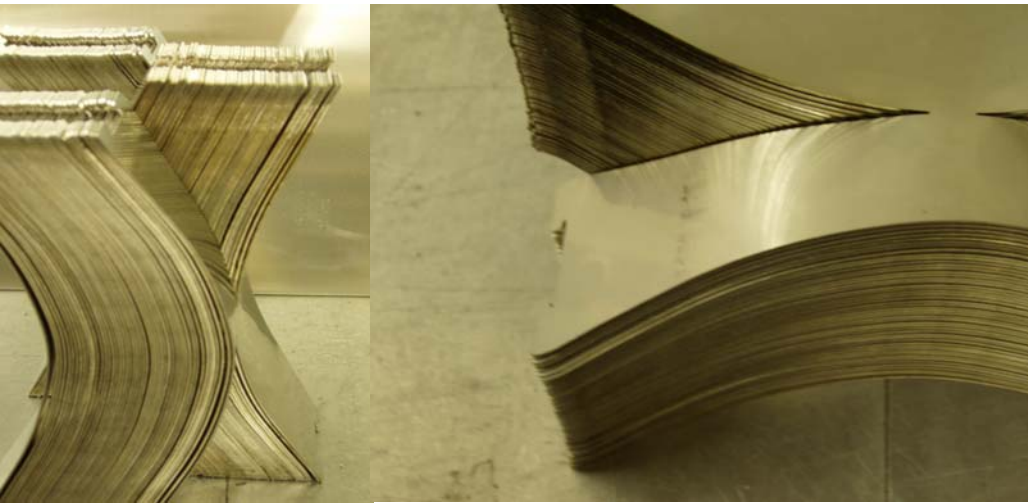

nds04-05:module08:steel:a02

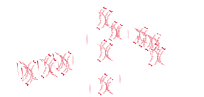

prototype



nds04-05:module08:steel:a02

 prototype



nds04-05:module08:steel:a02

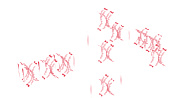

prototype

